



42371 Avenida Alvarado
Temecula, CA 92590
TOLL FREE (800) 454-2725
TEL (951) 296-3480
FAX (951) 296-3490
www.aquauv.com

Aqua Ultraviolet

UV Sterilizer Instruction Manual for Statuary UV's

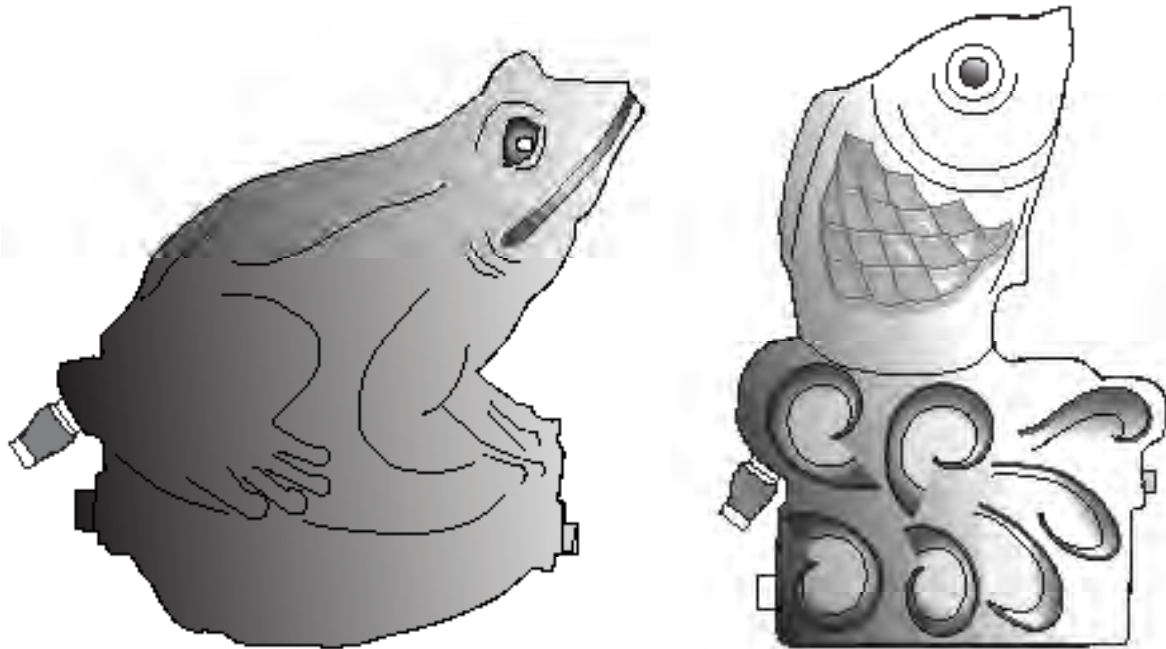

TABLE of CONTENTS

| | |
|-------------------------------------------------|----|
| Warranty. | 1 |
| Introduction. | 2 |
| How Ultraviolet Works. | 2 |
| Sizing Chart. | 3 |
| Recommended Pond Layout | 3 |
| Frequently Asked Questions. | 4 |
| Parts List. | 5 |
| Installation Instructions. | 6 |
| Trouble Shooting Leaks | 7 |
| Electrical Installation. | 8 |
| Filter Installation. | 11 |
| Winterizing. | 12 |
| Clean Out | 12 |
| Changing the Lamp | 13 |
| Cleaning or Changing the Quartz Sleeve. | 17 |
| Incorrect Installations. | 20 |



IMPORTANT INFORMATION

THANK YOU FOR PURCHASING
THE BEST STATUARY UV



**IF YOU HAVE ANY QUESTIONS
WE WILL BE HAPPY TO HELP**



In the US please call
TOLL FREE 1 - 800 - 454 - 2725
(951) 296-3480 Outside the U.S.
THANK YOU!

Returning the product is expensive and time consuming for you, your retailer and for us, the manufacturer. Should you encounter any problems with your product, please call our toll free "HELP" line for assistance. **PLEASE DO NOT** return your product to the store! Your dealer or distributor cannot offer any warranty work or exchanges on your product.

WARRANTY INFORMATION

Aqua Ultraviolet systems are warranted against failure due to defects in materials and/or workmanship during the warranty period. This warranty covers defects occurring under normal use and applies to the original retail purchaser and may not be transferred. The warranty and remedies set forth herein are conditional upon proper storage, installation, use, maintenance and conformance with the applicable use. It will be based upon Aqua Ultraviolet's discretion as to whether the defects are of manufacturing origin. Any damages due to shipping and handling, packing, or installation are not covered by this warranty.

This warranty does not apply to appearance or accessory items. This warranty does not include damage due to handling, transportation, unpacking, set up, installation, improper maintenance, incorrect line voltage, modification, abuse, misuse, neglect, accident, fire, flood, acts of God or repair or replacement of parts supplied by any other than Aqua Ultraviolet.

Any oral statements about product made by the seller, the manufacturer, their representatives or any other parties do not constitute warranties and shall not be relied upon by the user and are not part of this contract.

Neither the seller nor the manufacturer shall be liable for any injury, loss or damages, direct, incidental or consequential including but not limited to lost profits, lost sales, injury, inability to use the product and the user agrees that no other remedy is available.

Before installing, the user shall determine the suitability of the product for their intended use and the user shall assume all risk liability whatsoever in connection therewith.

To validate this warranty, mail the enclosed warranty card within 10 days of purchase along with proof of purchase (copy of sales receipt).

Warranty Period:

Housing: Limited lifetime warranty on housing against Ultraviolet degradation.

Complete Unit: One year from the date of purchase or 18 months from manufacturing date.

Limitations:

Warranty does not cover any malfunction from improper installation (we recommend that a licensed electrician install your system to the specifications outlined in this owners guide).

Warranty only applies to the original end user and is not transferable.

Warranty does not cover repairs done by anyone other than Aqua Ultraviolet.

Warranty is void if system is not plugged into a G.F.C.I. (Ground Fault Current Interrupter).

Warranty may not be modified by verbal statements by Aqua Ultraviolet, distributors, retailers, their agents or any other party.

Warranty covers the repair or prorated replacement of the Aqua Ultraviolet products. Aqua Ultraviolet denies all liability for any other loss including but not limited to loss of equipment, income, livestock or personal injury.

There is no warranty on the Quartz Sleeve.

There is no warranty on broken lamps. Lamps are prorated by usage.

Warranty is voided by the following:

Product labels defaced or removed.

Housing has been painted.

Product is improperly installed or maintained by user or agent.

Product abused, misused or damaged by user or their agent.

Product damage caused by electrical surges, electrical spikes, electrical brown outs or improper voltage.

Electrical cord has been cut.

Unit was run without water.

Any implied warranty granted under state law including warranties of merchantability or fitness for a particular purpose are limited to one year from the date of purchase or 18 months from the date of manufacture or as otherwise stated in the above warranty. Aqua Ultraviolet is not responsible for direct, indirect, incidental or consequential damages. Some states do not allow limitations on how long an implied warranty lasts and/or does not allow the exclusions or limitations of incidental damages so the above limitation and exclusion may not apply to you. This warranty gives you special legal rights and you may also have other rights that vary from state to state.

We at Aqua Ultraviolet would like to take the time to thank you for purchasing the finest Ultraviolet System on the market.

For over thirty years, Aqua Ultraviolet has manufactured Ultraviolet Systems used in various industries, including aquaculture, public and commercial aquariums, educational institutions, government agencies and research organizations throughout the world.

Aqua Ultraviolet Sterilizers are used as a control to destroy single celled organisms, water borne bacteria, viruses, algae, fungi and protozoa. Aqua Ultraviolet sterilizers are recommended for both fresh and salt water systems as well as ponds. There are no residual effects when using an Aqua Ultraviolet Sterilizer. Ultraviolet will not affect Bio-filters or lower fish immune systems!

HOW ULTRAVIOLET WORKS

The Ultraviolet Lamp emits a germicidal ray which alters or disrupts the DNA or RNA of single celled organisms such as algae, bacteria and protozoa. By properly implementing an Aqua Ultraviolet System in-line, these organisms can be eradicated effectively without any harmful residuals.

Your Aqua Ultraviolet System was made to work as a control for green water and single celled organisms. This unit will not, nor will any other Unit, completely Sterilize your pond as the pond itself is not a Sterile Environment. As a control, this unit will effectively lower your water's bacterial count allowing your fish to stay healthier with less risk of disease.

The Aqua Ultraviolet Sterilizer works better on filtered water. Any debris in the water can inhibit UV Transmission.



CAUTION: READ ALL INSTRUCTIONS CAREFULLY BEFORE BEGINNING INSTALLATION OR OPERATION.

The manual should answer most of the questions that you may have about the installation, operation and use of your new Aqua Ultraviolet Sterilizer. View our installation videos at www.aquauv.com. If you need technical support, we offer this service for free by telephone (800) 454-2725, or by fax (951) 296-3490 M-F 8:00 am - 4:30 pm Pacific Standard time except selected holidays. You may reach us through the web at www.aquauv.com.

-sizing

| STATUARY UV | 120 Volt Amp Draw | Size Fresh Water Pond Clarifier In Gallons | | Size Fresh Water Sterilizer In Gallons | 30,000 $\mu\text{w}/\text{cm}^2$ (EOL) GPH |
|-------------|----------------------|-----------------------------------------------|--------------|-------------------------------------------------|-----------------------------------------------------|
| | | GALLONS | GPH / GPM | | |
| 8 Watt 1/L | 0.48 | 1,500 | 1,000 / 16.7 | 5-200 | 642 / 10.7 |
| 15 Watt 1/L | 0.48 | 2,000 | 1,800 / 30 | 200-500 | 700 / 11.7 |
| 25 Watt 1/L | 0.48 | 4,000 | 2,000 / 33.3 | 500-1,200 | 1,200 / 20 |

For optimum pond quality it is recommended that the pond water be turned over at least once an hour or a minimum of every 1-1/2 hours.

Use the sterilizer column for crystal clear water and bacterial control, in pond environments.

Sterilizer numbers are based on turning the water over a minimum of 1 to 1-1/2 times per hour for optimal results.

Use the clarifier column when the pond is partially in shade and has 50% plant coverage. This will improve water clarity resulting in a natural looking water garden environment.

Clarifier numbers are based on turning the water over every 2 to 3 hours.

UV dosage is calculated at the end of lamp life (14 months).

RECOMMENDED EQUIPMENT PLACEMENT LAYOUTS

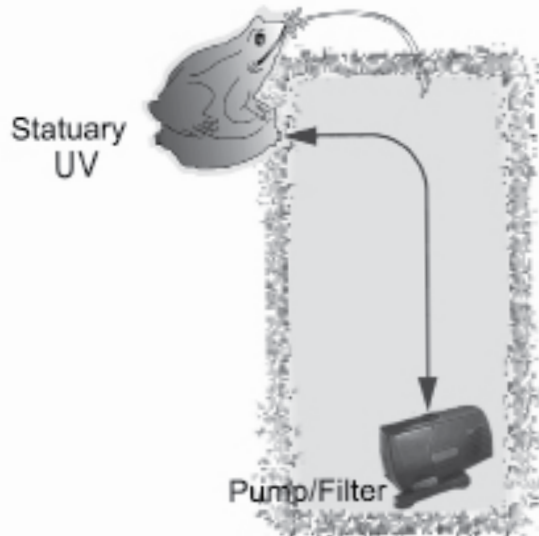

FREQUENTLY ASKED QUESTIONS

Where do I install my UV?

The best place to install your Aqua Ultraviolet Sterilizer is after the filter. If an after the filter installation is not feasible, your sterilizer can be installed before the filter, but it will take a little longer to work. If installed before the filter, be aware that a small rock passing from the pump can break the quartz sleeve. It is recommended that if you install your unit before your filter, you check the UV periodically for any water leakage due to a broken quartz sleeve. Be sure to have adequate pre-filtration to prevent breakage of the quartz sleeve (A broken quartz sleeve and any damage caused by a broken quartz sleeve is not covered under warranty.)

Do I have to turn my UV off when I clean my filter?

Yes, but only if the chamber is drained or if the water will remain at a stand still for more than 30 minutes. Note: Running longer than the recommended time without water flow can cause extensive damage to the unit.

What should I expect after my UV is installed?

If your Aqua Ultraviolet system is installed after the filter and is properly sized the water should be clear in 3-5 days. If your Aqua Ultraviolet system is installed before the filter the water should be clear in 7-10 days. The green algae on the sides and bottom of the pond will not disappear, this is normal and beneficial in a pond. The UV will only control free floating algae.

What's the difference between a sterilizer and a clarifier?

As a sterilizer, your Aqua UV system will keep your pond water crystal clear. You will have the added benefit of bacterial control which will help keep your fish healthy by reducing the risk of spreading-disease.

To use your UV as a clarifier and get crystal clear water you will need 50-75% plant coverage or full shade. Without plants and shade the clarifier will give a natural green tint to your pond.

What should my flow rate be on my pond?

The optimum flow rate on your pond is to turn over the volume of water a minimum of 1 to 1-1/2 times per hour.

Is this unit submersible?

No, not this specific series.

Does the UV light have any residual effect to the fish?

No, UV only affects what passes through the chamber. There is no residual effect from UV light.

Does the UV kill good bacteria?

Ultraviolet light does not discriminate about what it destroys. If good bacteria passes by the light it will be destroyed. Beneficial bacteria are colonized in your filter, along the sides and bottom of your pond. The only time these will be affected is if they become free floating and pass thru the UV.

PARTS LIST

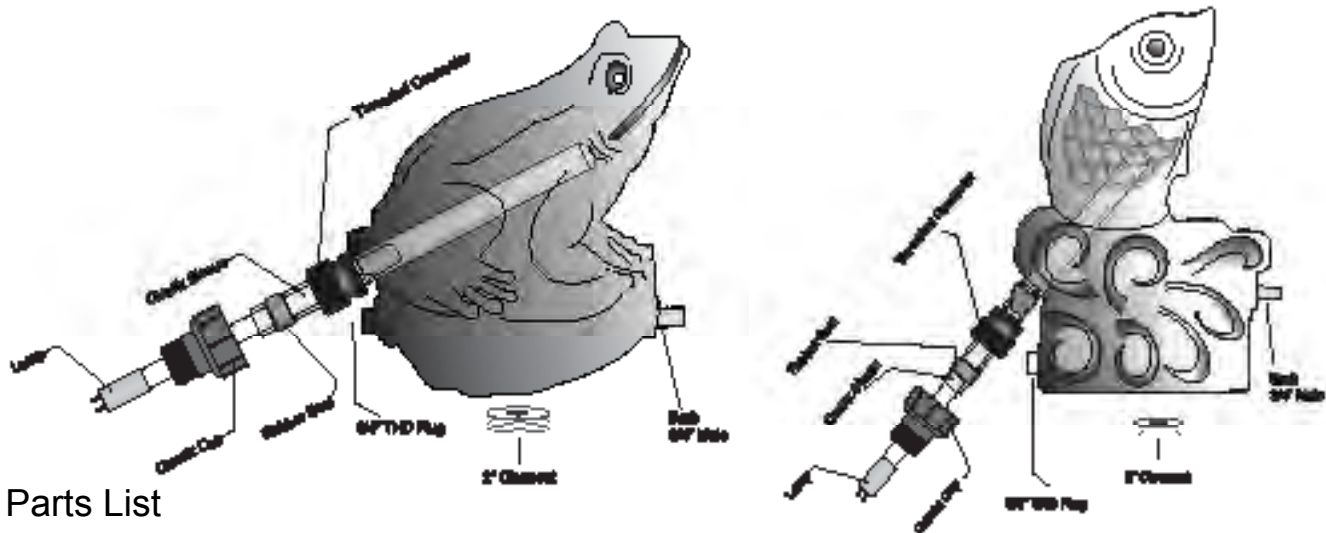

Parts List

| PART # | DESCRIPTION | PART # | DESCRIPTION |
|--------|---------------------|--------|--------------------|
| A40000 | Quartz Cap, Black | A40072 | 3/4" Threaded Plug |
| A40004 | Rubber Seal, Purple | A40074 | 2" Clean Out Plug |
| A40108 | Threaded Connector | A40054 | 3/4" Male Barb |

| UV Lamps | Part Number |
|----------------------------|-------------|
| 8 Watt 11-5/8" | A20008 |
| 15 Watt 11-5/8" | A20015 |
| 25 Watt 17-1/2" | A20025 |
| UV Quartz Sleeve | Part Number |
| Statuary Quartz Sleeve 19" | A10021 |

STATUARY TRANSFORMERS

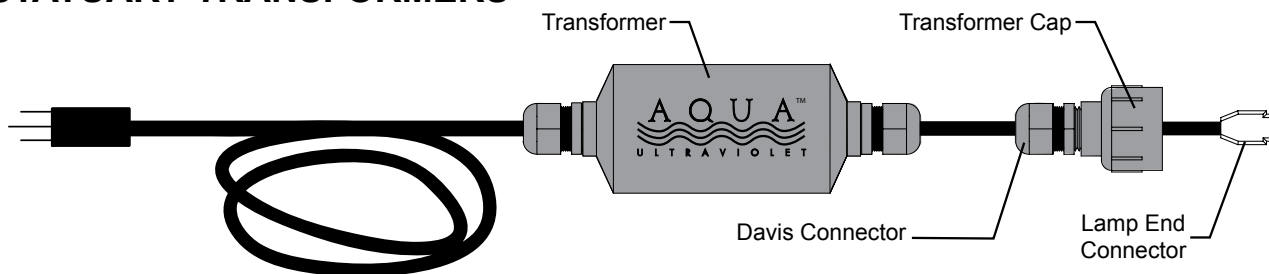

Transformer Parts List

| PART # | DESCRIPTION | PART # | DESCRIPTION |
|--------|---------------------------------|--------|-----------------------|
| A30019 | Frog / Fish 8 Watt Transformer | A40109 | Davis Connector |
| A30020 | Frog / Fish 15 Watt Transformer | A40113 | Transformer Cap Black |
| A30021 | Frog / Fish 25 Watt Transformer | A40002 | Lamp End Connector |

STATUARY INSTALLATION INSTRUCTIONS

1. Choose a location at the edge of the pond and make sure that the Statuary UV is set on a stepping stone or firm ground. It is important to make sure that the edge of the pond will not become water logged. This unit is not submersible and should be situated so that it cannot sit in or fall into the water.

2. Insert the Male Barb in either the front or the back of the Statuary Unit. Insert the 3/4 Threaded Plug into the unused port.



3. The Barb can be either 1/2" or 3/4"

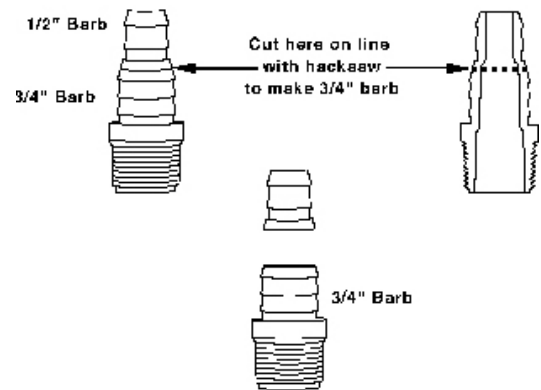

4. Connect to your existing pump with a flexible hose and secure with hose clamps (hose clamps are not included, purchase separately along with your hose).
5. Before you install the UV Lamp, Transformer and plug in the electrical cord a Leak Test must be conducted.
6. **LEAK TEST:** Do not install Lamp or electrical components yet. After all the hose connections have been made, turn the pump on and run it for five minutes to check for leaks.
 - a. If you have a leak, return to Trouble Shooting Leaks on page 7. Carefully examine the unit after installation. This unit should not be plugged in if there are any leaks on any part of the unit.
 - b. If there are no leaks, continue with electrical installation.

TROUBLE SHOOTING LEAKS

LEAKS FROM THE MALE BARB OR 3/4" THREADED PLUG

1. Place Teflon tape on the threads and re-tighten.

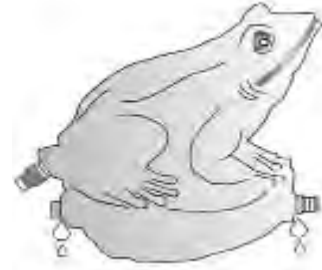

LEAKS FROM THE CLEAN OUT PLUG

2. Place Teflon tape on the threads and re-tighten.



LEAKS FROM THREADED CONNECTOR

3. Place Teflon tape on the threads and re-tighten.



LEAKS FROM THE QUARTZ CAP / RUBBER SEAL

4. Undo Quartz Cap and push Rubber Seal into the body of the Statuary Unit evenly. Half the Rubber Seal will still be in view. Screw on the Quartz Cap and hand tighten. Do not use a pipe wrench, pliers or any other tool. Hand-tighten only.



LEAKS FROM THE CENTER OF THE QUARTZ SLEEVE

5. The Quartz Sleeve is broken and needs to be replaced. Neither the broken Quartz Sleeve nor any damage caused as a result of a broken Quartz Sleeve is covered under warranty. Contact your dealer for a replacement. (See Changing the Quartz Sleeve on page 17).

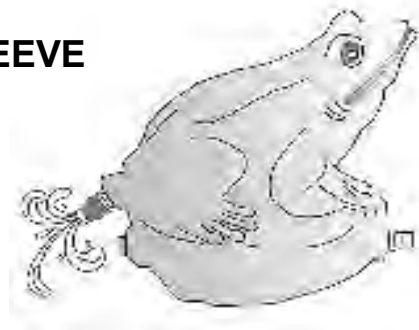

ELECTRICAL INSTALLATION

1. Unscrew the Davis Connector located just above the Transformer Cap. This will allow the Transformer Cap to turn without kinking the electrical cord.

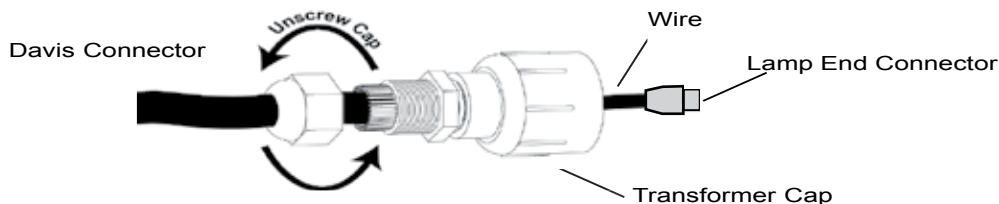

2. Prevent finger marks on the lamp. If you touch the Lamp use denatured alcohol and a soft cloth to clean the lamp.



NOTE: The Lamps and Quartz Sleeves should be handled with care. Lamps and Quartz Sleeves are not warranted against breakage and damage.

3. Plug the Lamp into the Transformer; make sure the Lamp is plugged in all the way and flush with the Lamp End Connector.

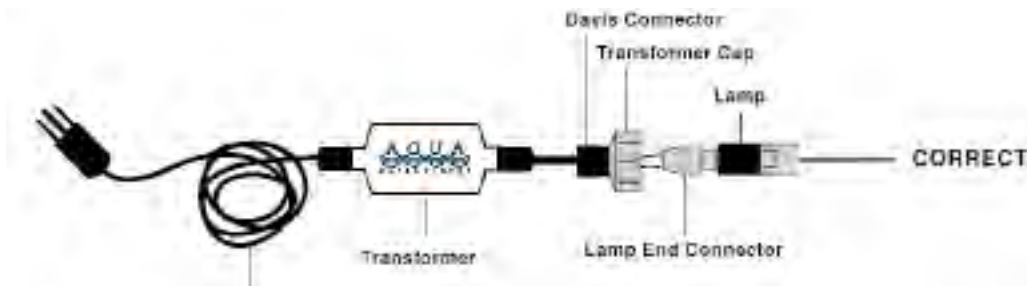

WARNING: Be careful when installing the Lamp. If the Lamp is not plugged in all the way this may cause damage to the Unit and is not covered under warranty, nor is any other damage caused by improper installation.

4. To install the Lamp place the Statuary Unit on a sturdy work area with the mouth facing down.



ELECTRICAL INSTALLATION



CAUTION: Do not look at or handle UV Lamps when lit outside of the housing. Considerable Ultraviolet Energy is emitted which may produce severe sunburn and/or conjunctivitis. As long as the UV Light is in its housing it is 100% safe for humans and fish.



NOTE: The average life expectancy of Aqua Ultraviolet Lamps is 14 months of continuous operation. After 14 months the Lamp may still light, but the germicidal rays are diminished. Be sure to change your Lamp after 14 months of use.



NOTE: We recommend that the Statuary UV be used in Continuous Operation 24 Hours a Day, 7 days a week. Frequent Starts and Stops may shorten the life of your Lamp.



WARNING: If you are medicating your fish, we recommend shutting down the Sterilizer as the UV Radiation may affect the treatment.



CAUTION: Do not use the Aqua Ultraviolet Sterilizer for anything other than its intended use.

- Slide the Lamp straight into the Statuary Body. An angle, even a slight angle may cause a "U" shaped crack at the end of the Quartz Sleeve, or possible breakage of the Lamp. If this should happen, do not proceed with the installation. Purchase a new Quartz Sleeve or Lamp from your dealer. Do not force the Lamp into the Quartz Sleeve; any force would be an indication of an improper installation

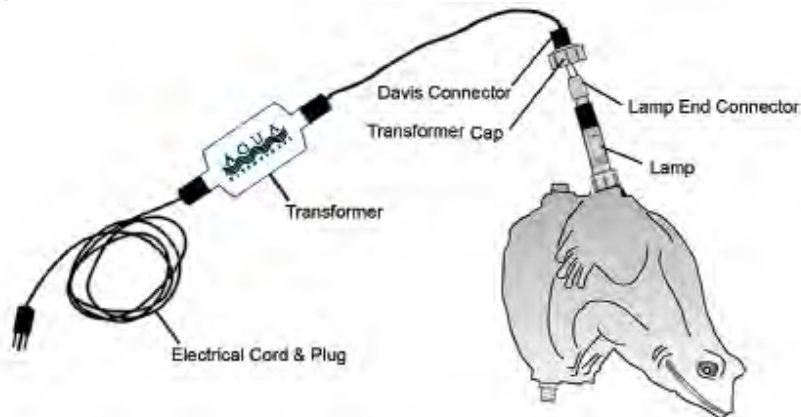

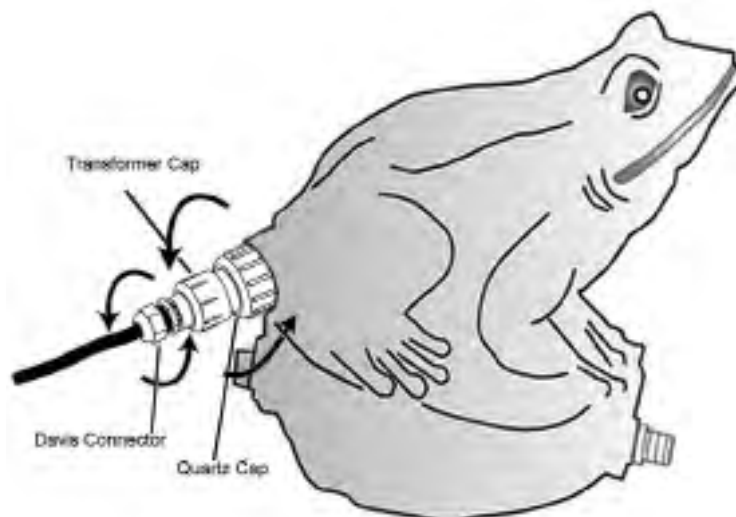

- Twist on the Transformer Cap. Do not over tighten. This is a connection only and is not in contact with water. Do not use a pipe wrench, pliers or any other tool, hand tighten only.

- Tighten the Davis Connector located just above the Transformer Cap.





8. Turn Statuary Unit upright and place into position at ponds edge
9. **FINAL LEAK CHECK:** Do not plug the Sterilizer into power yet, turn on pump and check for leaks again.
 - a. **If you have a leak, return to Trouble Shooting Leaks on page 7. Carefully examine the Unit after installation. This Unit should not be plugged in if there are any leaks on any part of the Unit.**
 - b. **If there are no leaks, turn on power.**

 **CAUTION: G.F.C.I. Information:** The warranty is null and void if the Statuary Unit is not plugged into a G.F.C.I. (Ground Fault Circuit Interrupter). A Surge Suppressor should be added for extra protection, it is not required, but recommended.

 **CAUTION:** Improper connection of the equipment to a grounding conductor can result in the risk of electrocution. Check with a qualified electrician or service person if there is any doubt the outlet is being properly grounded. Do not modify the plug provided with the Unit; if the plug does not fit the outlet have a proper outlet installed by an electrician

 **CAUTION:** Do not lay the Transformer on the ground. Prevent the Transformer from lying in standing water.

 **CAUTION:** Do not operate the Unit if it has a damaged cord or plug, if it is malfunctioning, or if it has been dropped or damaged in any manner.

 **CAUTION:** If the Unit falls into the water, DO NOT reach for it. First unplug the Unit and then retrieve it. If the electrical components of the Unit get wet unplug the unit immediately.

 **CAUTION:** If an extension cord is necessary a cord with a proper rating should be used, a cord rated for fewer amperes or watts than the Unit rating may overheat. Care should be taken to arrange the cord so that it will not be tripped over or pulled.

FILTER INSTALLATION

Filters can be incorporated with the Statuary UV. Follow the filter manufacturers installation instructions on how to connect the filter to the pump.

1. On the return line from the filter or pump attach a 1/2" or 3/4" hose to the Barb.

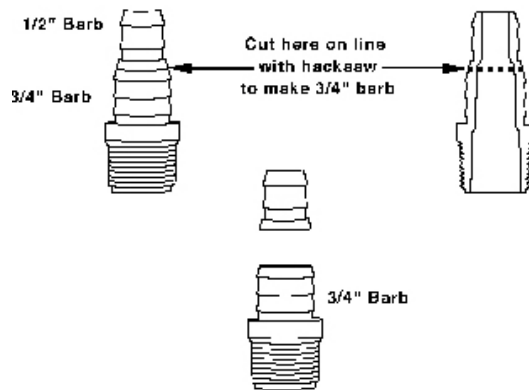

2. Install either to the back or front of the Statuary UV. Insert the 3/4" Threaded Plug into the unused port.



3. Cut and size hose, connect to the Statuary UV and the pump with hose clamps do not over tighten. Keep this run as short as possible to avoid kinks or bends. The pump should be as far away from the Statuary UV as possible for optimal water circulation. Keep in mind the length and run of the needed hose when purchasing, measuring and cutting.

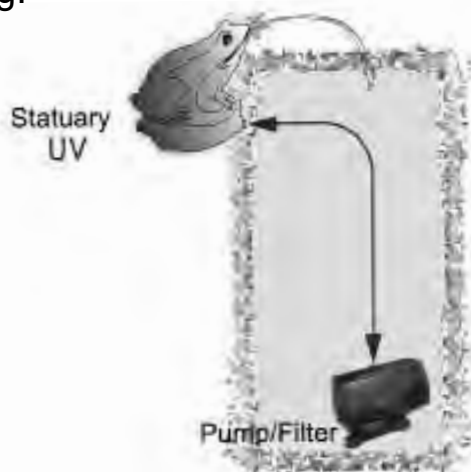



CAUTION: Always turn off the pump and disconnect electricity from the Unit prior to any maintenance.

1. Protect the Statuary UV from frost or freezing. In cold weather the Statuary UV should be unplugged, drained of water and the lamp removed and stored in a dry area. Do not allow unit to be exposed to freezing temperatures, severe damage and or breakage to the Unit, Lamp and or Quartz Sleeve may result and is not covered under warranty

CLEAN OUT PLUG

1. Unplug the Unit from power
2. Remove the Lamp and Transformer
Refer to page 13
3. Drain the water out.
4. Place the Statuary Unit on a sturdy work area with the mouth facing down. Unscrew Clean Out Plug to get out any debris when necessary.

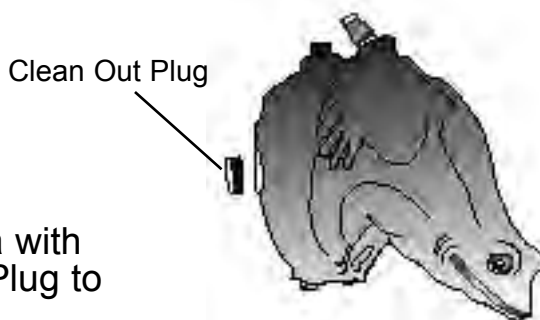

CHANGING THE LAMP



WARNING: Use only genuine AQUA ULTRAVIOLET replacement parts when changing your lamp. This is a specialized lamp, while others may look similar they are not the same. Other lamps will not produce the same result and can damage your Statuary UV.



CAUTION: Always turn off the pump and disconnect the electricity from the unit prior to any maintenance.

1. Unplug the Statuary Unit from power source and drain the water out.
2. Place the Statuary Unit on a sturdy work area with the mouth facing down.

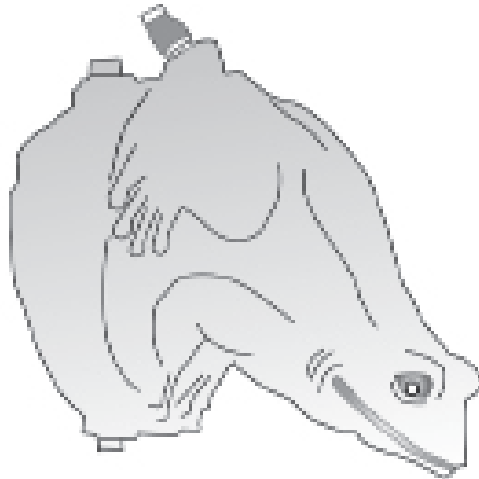

3. Unscrew the Davis Connector located just above the Transformer Cap. This will allow the Transformer Cap to turn without kinking the electrical cord.
4. Twist off the Transformer Cap.

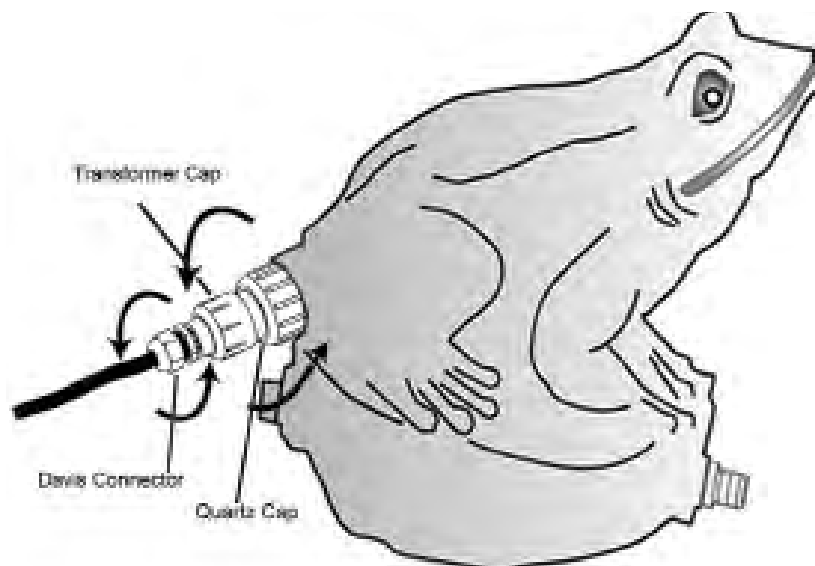

- Slide the Lamp out of the Statuary Body. An angle, even a slight angle may cause a “U” shaped crack at the end of the Quartz Sleeve, or possible breakage of the Lamp. If this should happen, do not proceed with the installation. Purchase a new Quartz Sleeve or Lamp from your dealer. Do not force the Lamp out of the Quartz Sleeve; any force would be an indication of an improper removal.

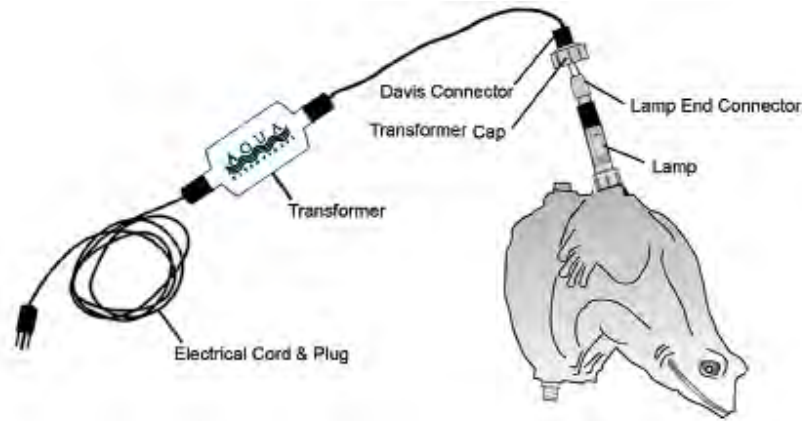

- Unplug Lamp from Transformer and discard the Lamp.
- Prevent finger marks on the new Lamp. If you touch the Lamp use denatured alcohol and a soft cloth to clean it.



NOTE: The Lamp and Quartz Sleeve should be handled with care. Lamps and Quartz Sleeves are not warranted against breakage and damage.

- Plug the new Lamp into the transformer; make sure the Lamp is plugged in all the way and flush with the Lamp End Connector.

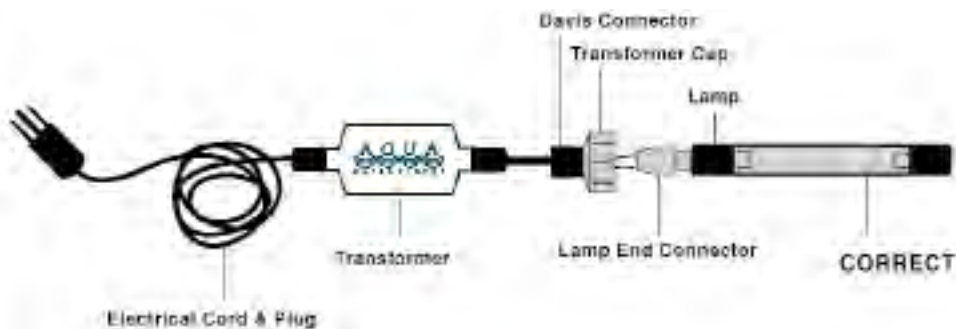

WARNING: Be careful when installing the Lamp. If the Lamp is not plugged in all the way this may cause damage to the Unit and is not covered under warranty, nor is any other damage caused by improper installation.

CHANGING THE LAMP



CAUTION: Do not look at or handle UV Lamps when lit outside of the housing. Considerable Ultraviolet Energy is emitted which may produce severe sunburn and/or conjunctivitis. As long as the UV Light is in its housing it is 100% safe for humans and fish.



NOTE: The average life expectancy of Aqua Ultraviolet Lamps is 14 months of continuous operation. After 14 months the Lamp may still light, but the germicidal rays are diminished. Be sure to change your Lamp after 14 months of use.



NOTE: We recommend that the Statuary UV be used in Continuous Operation 24 Hours a Day, 7 Days a week. Frequent Starts and Stops may shorten the life of your Lamp.



WARNING: If you are medicating your fish, we recommend shutting down the Sterilizer as the UV Radiation may affect the treatment.



CAUTION: Do not use the Aqua Ultraviolet Sterilizer for anything other than its intended use.

- Slide the Lamp straight into the Statuary Body. An angle, even a slight angle may cause a "U" shaped crack at the end of the Quartz Sleeve, or possible breakage of the Lamp. If this should happen, do not proceed with the installation. Purchase a new Quartz Sleeve or Lamp from your dealer. Do not force the Lamp into the Quartz Sleeve; any force would be an indication of an improper installation

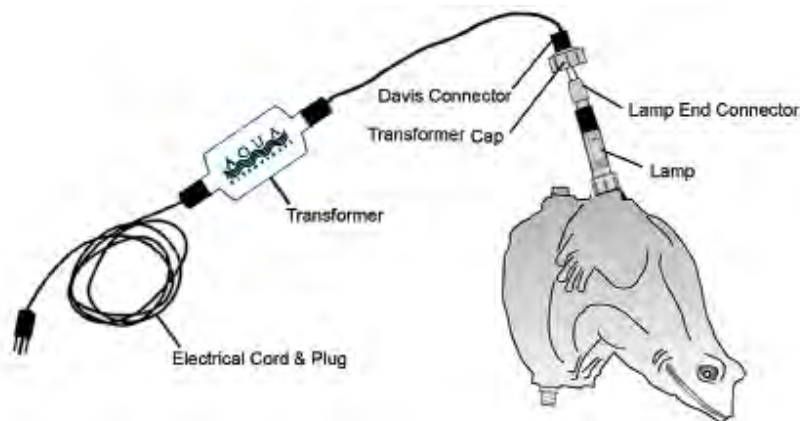

- Twist on the Transformer Cap. Do not over tighten. This is a connection only and is not in contact with water. Do not use a pipe wrench, pliers or any other tool, hand tighten only.

- Tighten the Davis Connector located just above the Transformer Cap.

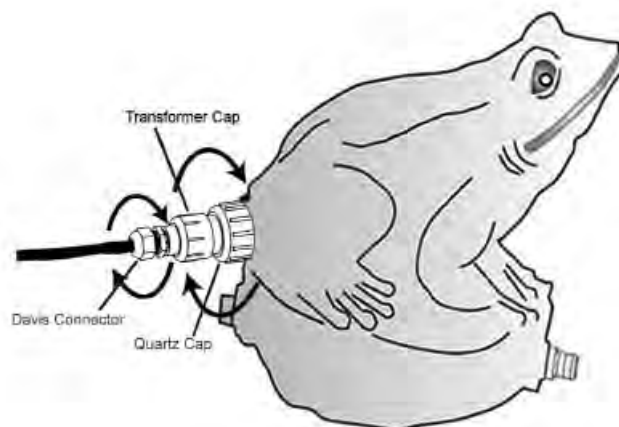

12. Turn Statuary Unit upright and place into position at ponds edge
13. **FINAL LEAK CHECK:** Do not plug the Sterilizer into power yet, turn on pump and check for leaks again.
 - a. **If you have a leak, return to Trouble Shooting Leaks on page 7. Carefully examine the Unit after installation. The Unit should not be plugged in if there are any leaks on any part of the Unit.**
 - b. **If there are no leaks, turn on power.**



CAUTION: G.F.C.I. Information: The warranty is null and void if the Statuary Unit is not plugged into a G.F.C.I. (Ground Fault Circuit Interrupter). A Surge Suppressor should be added for extra protection, it is not required, but recommended.



CAUTION: Improper connection of the equipment to a grounding conductor can result in the risk of electrocution. Check with a qualified electrician or service person if there is any doubt the outlet is being properly grounded. Do not modify the plug provided with the Unit; if the plug does not fit the outlet have a proper outlet installed by an electrician



CAUTION: Do not lay the Transformer on the ground. Prevent the Transformer from lying in standing water.



CAUTION: Do not operate Unit if it has a damaged cord or plug, if it is malfunctioning, or if it has been dropped or damaged in any manner.



CAUTION: If the Unit falls into the water, DO NOT reach for it. First unplug the Unit and then retrieve it. If the electrical components of the Unit get wet unplug the Unit immediately.



CAUTION: If an extension cord is necessary a cord with a proper rating should be used, cord rated for fewer amperes or watts than the Unit rating may overheat. Care should be taken to arrange the cord so that it will not be tripped over or pulled.

CLEANING OR CHANGING THE QUARTZ



CAUTION: Always turn off the pump and disconnect the electricity from the Unit prior to any maintenance.

1. Unplug the Unit from power and drain the water out.
2. Place the Statuary Unit on a sturdy work area with the mouth facing down.

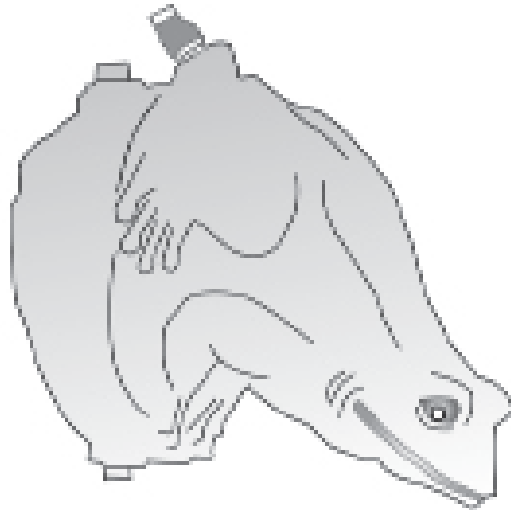

3. Unscrew the Davis Connector located just above the Transformer Cap. This will allow the Transformer Cap to turn without kinking the electrical cord.
4. Twist off the Transformer Cap.

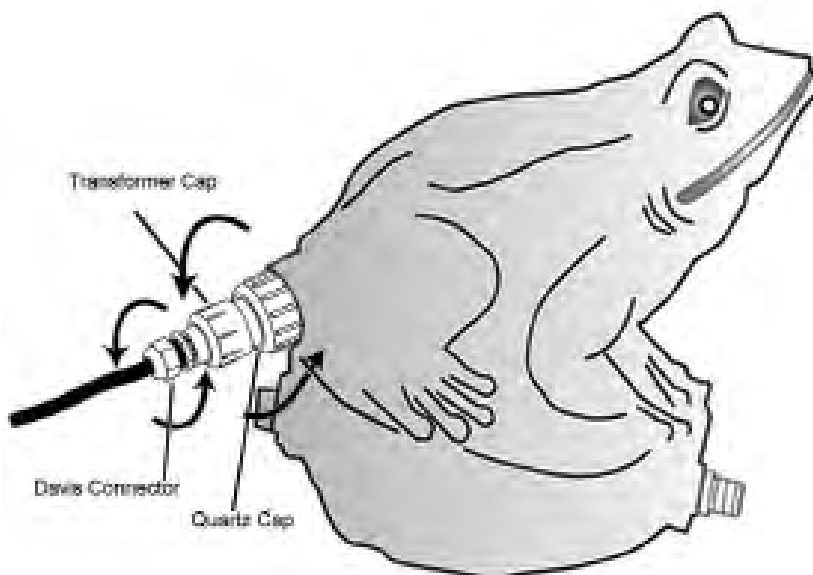

CLEANING OR CHANGING THE QUARTZ

- Slide the Lamp out of the Statuary Body. An angle, even a slight angle may cause a “U” shaped crack at the end of the Quartz Sleeve, or possible breakage of the Lamp. If this should happen, do not proceed with the installation. Purchase a new Quartz Sleeve or Lamp from your dealer. Do not force the Lamp out of the Quartz Sleeve; any force would be an indication of an improper removal.

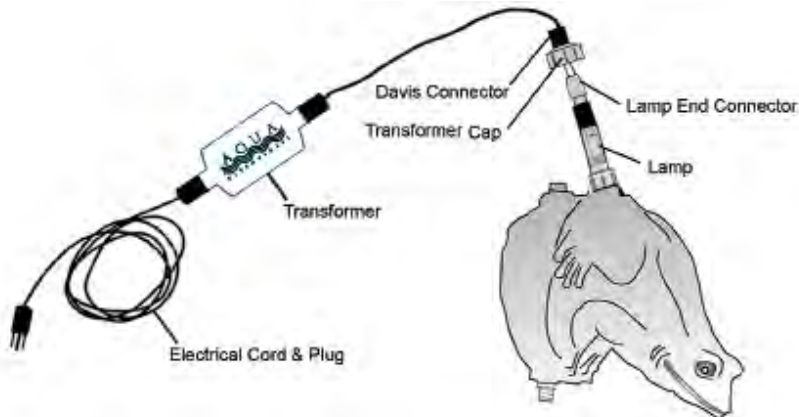

- Remove the Quartz Cap.



NOTE: The Lamp and Quartz Sleeve should be handled with care. Lamps and Quartz Sleeves are not warranted against breakage and damage.

- Using a soft cloth, grasp the Quartz Sleeve and Rubber Seal turn and pull the Quartz Sleeve along with its Rubber Seal out.

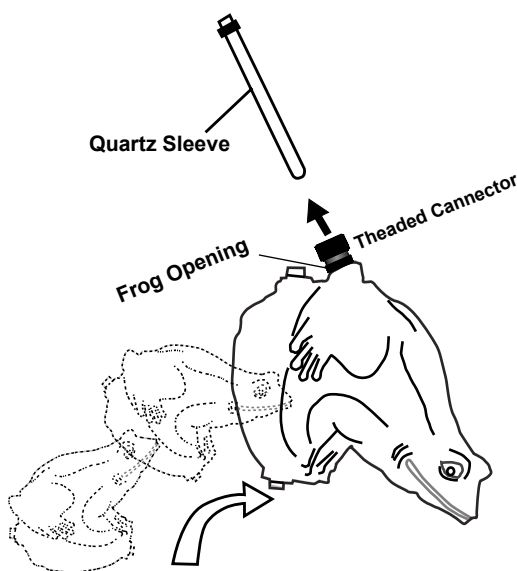

- Once the Quartz Sleeve is removed it can be cleaned with Lime Away or similar products.

CLEANING OR CHANGING THE QUARTZ

9. To reinstall the Quartz Sleeve, carefully insert the Quartz Sleeve into the end of the Statuary Unit.

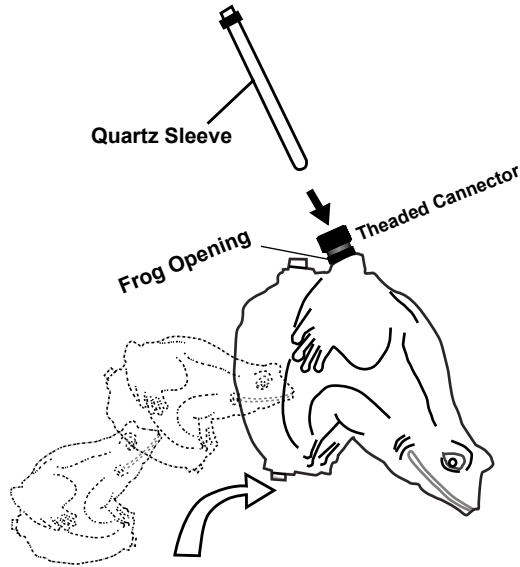

10. Push the Rubber Seal into the UV until it touches the inner rim of the Threaded Connector. The Rubber Seal should be 1/4" from the end of the Quartz Sleeve 1/2 of the Rubber Seal should be visible.



11. Screw on the Quartz Cap. Do not use a pipe wrench, pliers or any other tool on this unit. Tighten by hand only.
12. **Run Leak Test** . Do not install Lamp or electrical components yet. After the Quartz Sleeve has been installed, turn on pump and run it for five minutes to check for leaks. If there are leaks see page 7 for solutions.
13. When there are no leaks install the lamp. Refer to steps 3 - 9 starting on page 8.

INCORRECT INSTALLATIONS

The following will damage the unit's electrical components and Quartz Sleeve.

INCORRECT:
Rubber Seal is Outside of Quartz Cap



INCORRECT:
Lamp at an Angle will Create a U Shaped Crack in Quartz Sleeve

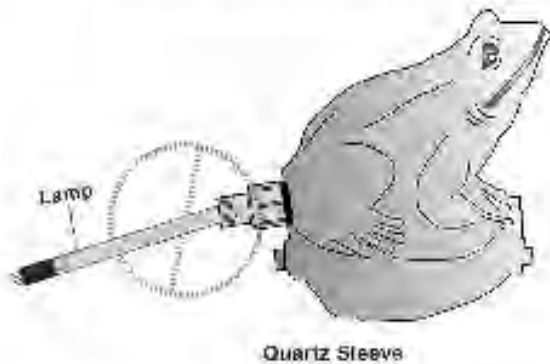

**Lamp Dropped in Quartz Sleeve
Can Cause Breakage**

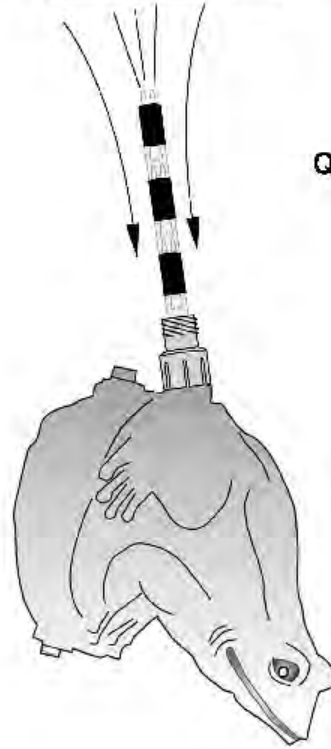

Quartz Sleeve

INCORRECT:
Lamp not Plugged Flush with
Lamp End Connector

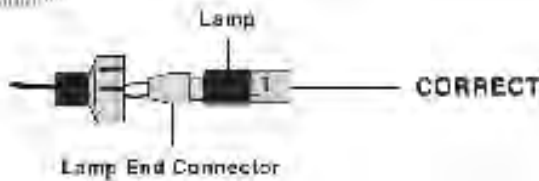
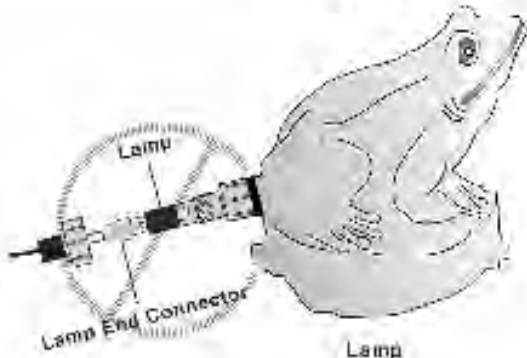



42371 Avenida Alvarado
Temecula, CA 92590
TOLL FREE: (800) 454-2725
TEL: (951) 296-3480
FAX: (951) 296-3490
www.aquauv.com